



Referans Nr.		d	g	k	 kgf	 (kg)
1530-200	200-300	Tr40x7	70	26	8000	10.0
1530-280	280-460	Tr40x7	70	26	6000	11.8
1530-430	430-750	Tr40x7	70	26	5000	14.2
1530-710	710-1250	Tr40x7	70	26	4000	20.9



Ürün Nr. 1530 Büyük Boy Yükseltici Destek

- Yüksek parçalarda kullanım amaçlı trapez diş yükseltici destek
- Malzeme GGG 60 Bağlama pabuçlu döküm gövde statik boyalı. Altı köşede bulunan Ø12mm delik Referans Nr. 1555-1560-1565-1570-1575 ürünlerle kullanıldığında farklı kullanım avantajı sağlar.

Product Nr. 1530 King Size Lifter Support

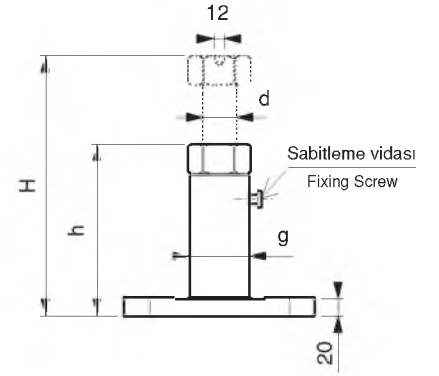
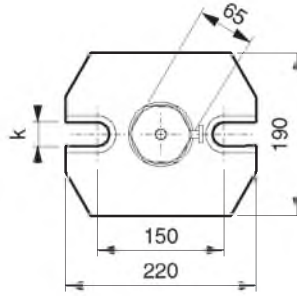
- This is a trapeze thread lifting support having the purpose of using with High Pieces.
 - Material GGG 60 and it is with Coupling Clamp and it has casting body and statical painting.
- It provides different usage advantages when Ø12mm hole is used with 1555-1560-1565-1570-1575 Reference Numbered products taking place.



Referans Nr.		d	g	k	 kgf	 (kg)
1550-100	100-140	Tr30x6	50	18	6000	2.05
1550-140	140-200	Tr30x6	50	18	6000	2.45
1550-200	200-320	Tr30x6	50	22	4000	3.90
1550-320	320-550	Tr30x6	50	22	2500	5.15

Ürün Nr. 1550 Büyük Boy Yükseltici Destek

- Yüksek parçalarda kullanım amaçlı trapez diş yükseltici destek
- Malzeme GGG 60 Bağlama pabuçlu döküm gövde statik boyalı. Altı köşede bulunan Ø12mm delik Referans Nr. 1555-1560-1565-1570-1575 ürünlerle kullanıldığında farklı kullanım avantajı sağlar.

Product Nr. 1550 King Size Lifter Support

- This is a trapeze thread lifting support having the purpose of using with High Pieces.
 - Material GGG 60 and it is with Coupling Clamp and it has casting body and statical painting.
- It provides different usage advantages when Ø12mm hole is used with 1555-1560-1565-1570-1575 Reference Numbered products taking place.

