



Referans Nr.		h min-max	f	c	L	b	 (g)
1250 - 02	14-16-18-20-22	80-137	3	17	110	38	2015
1250 - 03		125-224	3	17	110	38	2910
1250 - 04		160-300	3	17	110	38	3665

Ürün Nr. 1250 Kombine Bağlama Pabuçu



- Pabucun çift taraflı kullanım özelliği; kendi içinde bulunan kademeli yükseltici desteği ile kısıtlı alanlarda kullanım kolaylığı sağlar.
- DIN 650 "T" kanala uyumludur.
- Malzeme Ck45 DIN
- Pabuç sertlik 32-35 HRC
- Cıvata 10.9 kalite
- Siyah kaplama
- Sertlik 32-35 HRC

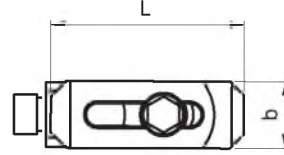

Product Nr. 1250 Combined Coupling Clamp

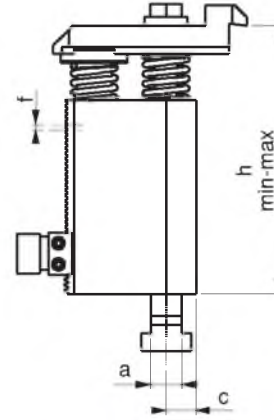
- Double-sided usage of the clamp and its stepped lifter's support provides using advantage in restricted areas
- It is suitable to DIN 650 "T" Slot
- Material: Ck45 DIN
- Clamp Hardness: 32-35 HRC
- Bolt Quality: 10.9
- Black coating
- Hardness: 32-35 HRC



Referans Nr.		h min-max	 DIN 787	b1	e	z	L	b	 (g)
1270-1012	12	0-45	M10x12x125	11	48	61	109	40	660
1270-1214	14	0-45	M12x14x125	13	48	61	109	40	705
1270-1416	16	0-55	M14x16x125	15	57	72	129	50	1190
1270-1618	18	0-55	M16x18x125	17	57	72	129	50	1265

Ürün Nr. 1270 Desteksiz Askı Pabuçu

- Destek kullanmadan 0-55 mm arası kullanım imkanı sağlar.
- Malzeme Ck45 DIN Dövme çelik
- Siyah kaplama
- Sertlik 32-35 HRC (Pabuç)

Product Nr. 1270 Unsupported Suspension Clamp

- Product provides using between 0-55 mm without using support
- Material: Ck45 DIN Forged Steel
- Black coating
- Hardness: 32-35 HRC (for Clamp)

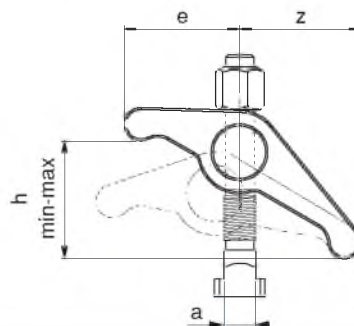
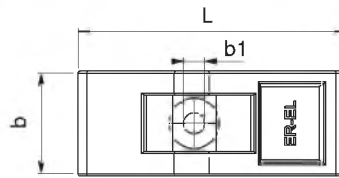

Desteksiz Askı Pabuçu

Unsupported Suspension Clamp

